

MMX™

Intelligent Fire Alarm Network



User Guide

Table of Contents

Introduction	1
About this Manual	1
Front Panel Indicators, Controls, and Operation	2
Front Panel Indicators and Control Locations (Model DSPL-420)	2
Front Panel Indicators and Control Locations (Model DSPL-420-16TZDS)	3
Common Indicators	4
Common Controls	5
Troubleshooting	8
Start Up	9
Passcodes	10
Factory Defaults	10
Menu Mode	11
Front Panel Menu Operation	12
1. Reports Menu	12
2. Bypass Menu	21
3. Walk Test Menu	25
Alternate Menu Option #3: Manual Control Enable	33
4. Day/Night Mode	34
5. Set Time	35
6. Clear Event Log	36
7. Clear Verification Counter	37
8. Network Restart	38
9. Configuration Info	38
10. Choose Configuration	39
Paging Operation	40
QMP-5101N and QMP-5101NV Network Master Paging Indicators and Controls	40
QMP-5101N/V LEDs	40
QMP-5101N/V Pushbutton Controls	41
QAZT-5302 Paging Selector Panel LEDs	42
QAZT-5302 Pushbuttons	42
Telephone Operation	43
QMT-5302N/QMT-5302NV Master Firefighters' Telephone Indicators and Controls	43
Telephone Operation	44
QMT-5302N Master Telephone LEDs	44
QMT-5302N Master Telephone Pushbutton Controls	44
QAZT-5302 Network Firefighters' Telephone Selector Panel LEDs	44
QAZT-5302 Network Firefighters' Telephone Selector Panel Pushbutton Controls	44

Introduction

About this Manual

This user guide provides information on the Command Menu features of the MMX™ Network Fire Alarm and Audio system which includes MMX-2003-12NDS, MMX-2003-12NXTDS, MMX-2009-12NDS, and MMX-2017-12NDS. Using the instructions provided in this manual, you will be able to:

- Print reports
- Bypass devices, circuits, loops, and disconnect relays
- Perform a walk test
- Change your passcode
- Clear logs and counters
- Set Day/Night mode
- Set Time

Front Panel Indicators, Controls, and Operation

Front Panel Indicators and Control Locations (Model DSPL-420)

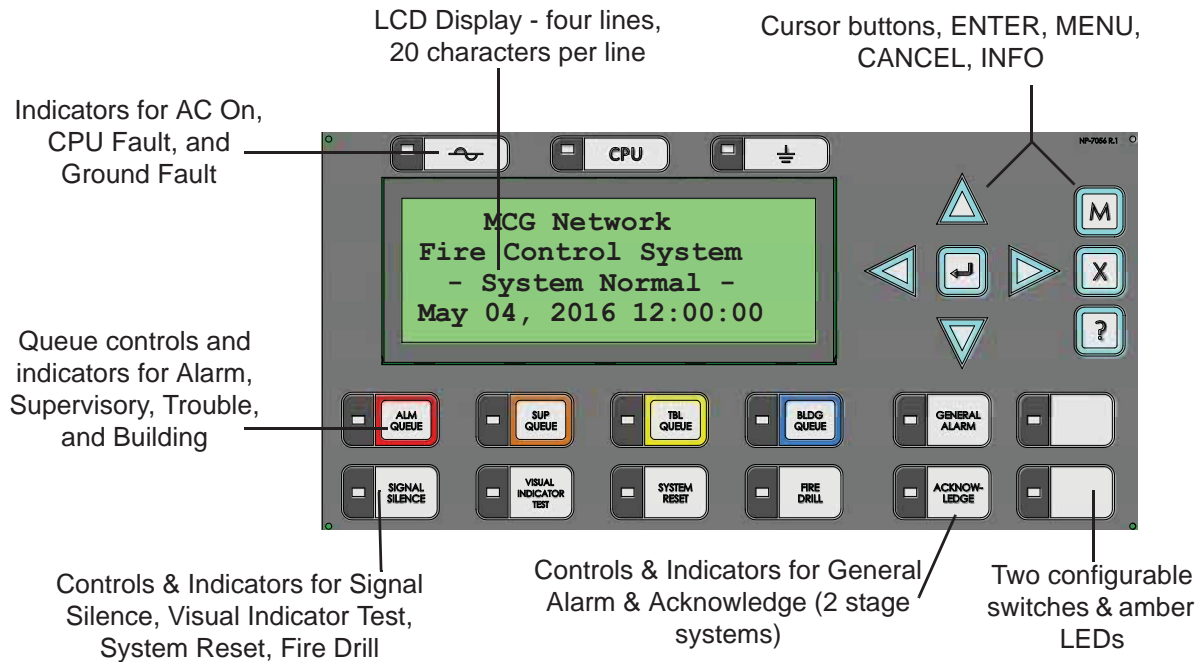

Note: The General Alarm LED and pushbutton, and the Acknowledge LED and pushbutton, are active only on a system configured for Two Stage.

Graphic Front Panel Indicators and Control Locations (Model DSPL-2440)

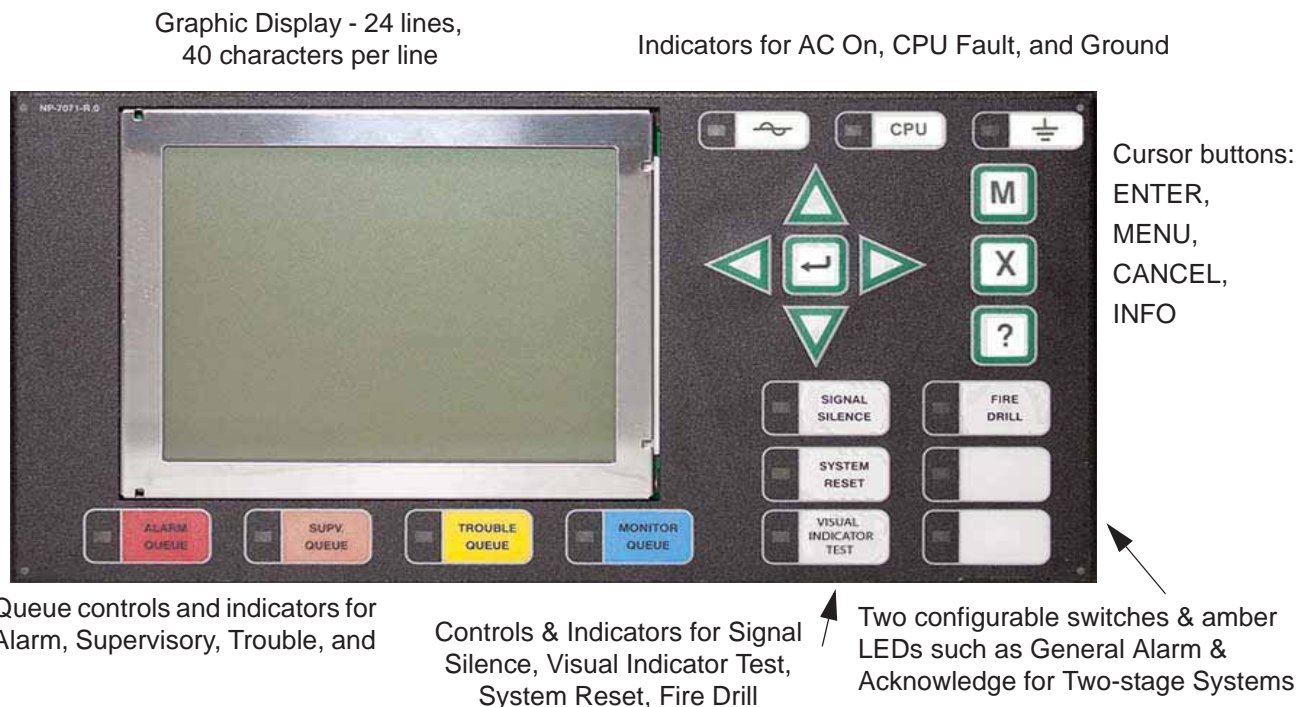

Front Panel Indicators and Control Locations (Model DSPL-420-16TZDS)

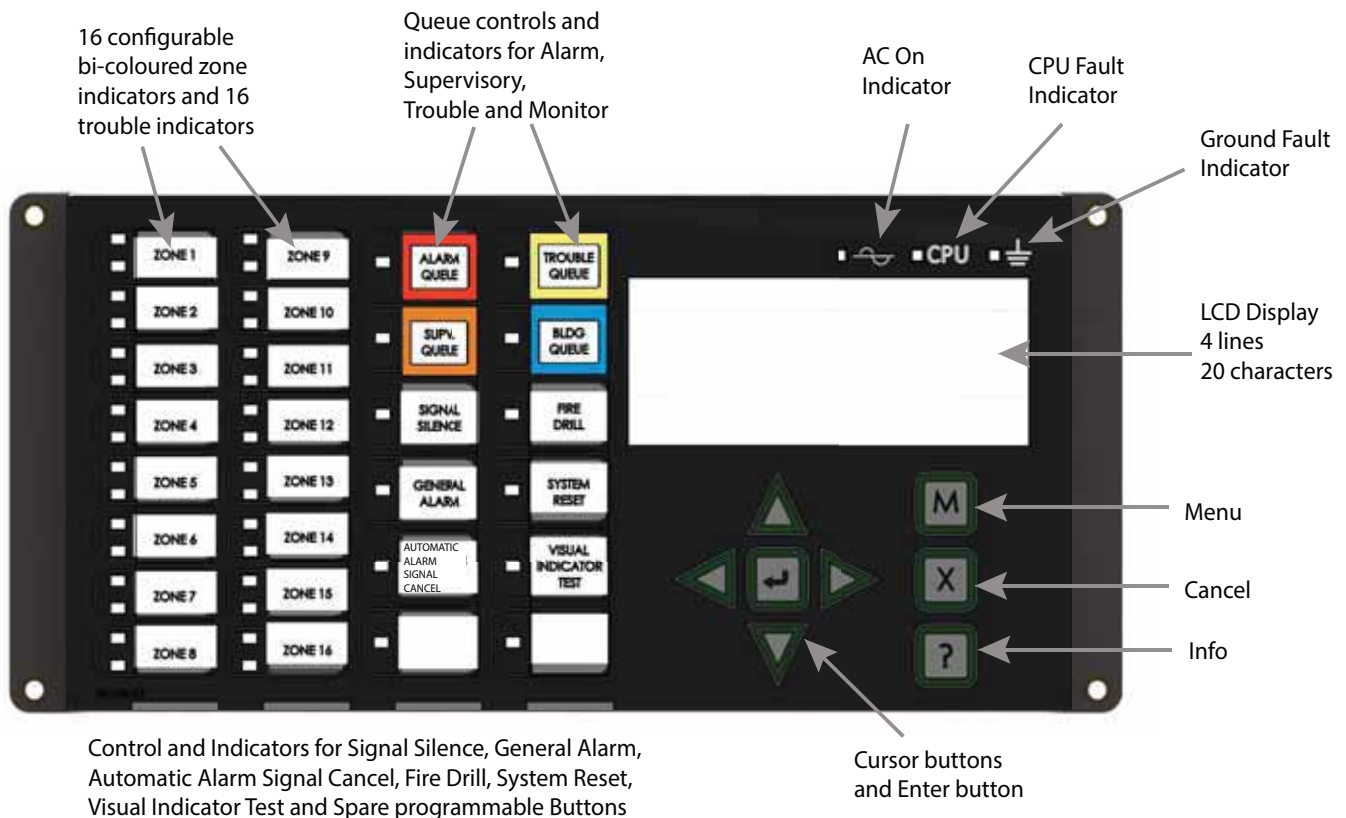

LED indicators are amber (trouble or supervisory), red (alarm), or green (AC ON), and may illuminate continuously (steady) or at one of two flash rates:

- **Fast flash:** 120 flashes per minute, 50% duty cycle
- **Trouble flash:** 20 flashes per minute, 50% duty cycle

Paper Labels for Buttons and Indicators

Buttons and indicators are supplied with paper labels. These labels slide into the plastic label templates on the face of the panel. Paper labels allow for easy English / French selection and custom-printed zone information.



Note: The Acknowledge LED and pushbutton, are active only on a system configured for Two Stage.

Common Indicators

Buzzer

The buzzer is activated by any of the following:

- **Fire alarm:** steady
- **Supervisory alarm:** fast flash rate
- **Trouble:** trouble flash rate
- **Monitor:** Configurable to sound at trouble flash rate

If the buzzer turns ON in response to a non-latching trouble or supervisory, it will turn OFF if the condition causing it goes away and there is no other reason for it to be ON.

AC ON LED

The AC ON LED illuminates steady green while the main AC power is within acceptable levels. It turns OFF when the power level falls below the power-fail threshold and the panel switches to standby (battery) power.



Alarm Queue LED

The Alarm LED flashes red whenever the panel is in alarm. An alarm results from any alarm on any point or input programmed as alarm or activation of the manual red General Alarm button. The Alarm Queue LED will illuminate steadily once *all* alarms in the queue have been reviewed using the Alarm Queue button. Since all alarms are latched until the panel is reset, the LED will remain ON until then.



Supervisory Queue LED

The Supv. (Supervisory) LED flashes amber when there is a supervisory alarm in the panel resulting from any latching or non-latching supervisory circuit. The LED turns OFF if all non-latching supervisory circuits are restored and there are no active latching supervisory circuits. The Supv. Queue LED will illuminate steadily once *all* supervisory alarms in the supervisory queue have been reviewed using the Supv. Queue button. Latching supervisory alarms remain active until the panel is reset.

Trouble Queue LED

The Trouble LED flashes amber at the trouble flash rate when the panel detects any trouble condition. The LED turns OFF after all non-latching troubles are cleared. The Trouble Queue LED will illuminate steadily once all troubles in the trouble queue have been reviewed using the Trouble Queue button.

Building Queue LED

The BLDG Trouble LED flashes amber at the trouble flash rate when the panel detects any building monitor condition. It turns OFF after all monitor troubles are cleared.

CPU Fault LED

The CPU Fault LED flashes amber at the trouble flash rate when the main CPU fails.

Ground Fault LED

The Ground Fault LED flashes amber at the trouble flash rate when the Ground Fault Detector detects a ground fault on any field wiring. It turns OFF after the fault is cleared.

Signal Silence LED

The Signal Silence LED flashes amber at the trouble flash rate after indicating circuits are silenced either by the Signal Silence button, or by the Auto Signal Silence Timer. It turns OFF after the signals are re-sounded by a subsequent alarm.

Fire Drill LED

The Fire Drill LED turns ON steady amber while Fire Drill is active.

General Alarm LED

The red General Alarm LED illuminates steadily after the General Alarm button is pressed, or after the Auto General Alarm Timer times out. Once the General Alarm LED turns ON, it will stay active until the panel is reset.

System Reset LED

The amber System Reset LED will illuminate steadily after the system reset button has been pressed and the system is resetting.

Acknowledge (or Automatic Alarm Signal Silence) LED

If the panel is configured as a Two Stage system, the Acknowledge LED flashes amber at the fast flash rate while the General Alarm timer is timing. It turns ON steady amber after the Auto General Alarm Timer is cancelled by the activation of the Acknowledge or Signal Silence buttons. If the Auto General Alarm Timer times-out and puts the panel into General Alarm, the Acknowledge LED turns OFF.

Visual Indicator Test (Lamp Test) LED

The amber Visual Indicator Test LED will illuminate steadily after the Visual Indicator Test button is pressed and while system is in visual indicator Test mode.

Configurable LED Indicators



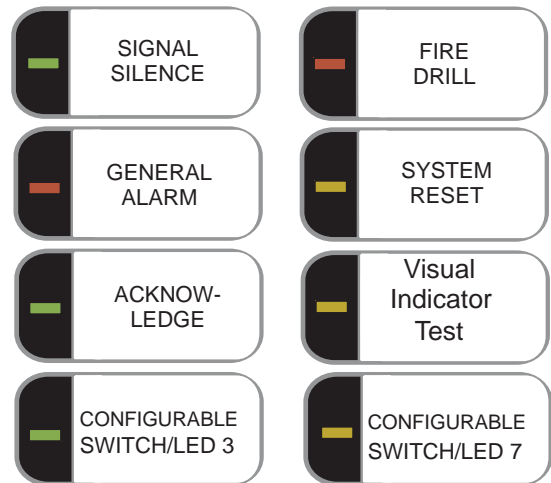





Configurable LED indicators include 16 bi-coloured LEDs that are available for alarm, supervisory, and monitor annunciation paired with 16 trouble LEDs available for trouble annunciation.

**Common Controls****LCD Display**

The display is a large, four line, 20 character back-lit alphanumeric LCD. It displays information regarding the panel, its circuits, and devices. An on-screen cursor is controlled by the cursor buttons (located to the right of the display) for menu selection and control. Report information provided by the LCD display include Alarm Log, Event Log, Current Levels, Verification, and Maintenance reports.

Queue Buttons

Use the queue buttons to select a particular queue to review.

- Use the **Alarm Queue** button to view all alarms. Pressing this button will show the latest alarm on the LCD display. Use  and  to view all previous alarms.
- Use the **Supervisory Queue** button to view all supervisory conditions. Pressing this button will show the latest supervisory information on the LCD display. Use  and  to view all previous supervisory conditions on the LCD display.
- Use the **Trouble Queue** button to view all trouble conditions. Pressing this button will show the latest trouble condition on the LCD display. Use  and  to view any previous troubles.
- Use the **Monitor Queue Button** to show all monitor conditions. Pressing this button will show the latest monitor information on the LCD display. Use  and  to view all queued monitor conditions.

Queues are displayed on the screen according to a priority sequence. Queue priority ranking from highest to lowest is as follows: alarm, supervisory, trouble, and monitor. If, for example, you are viewing a monitor queue and an alarm occurs, the display will immediately display the alarm condition. Also, if there is no activity on the system for 10 seconds after you have pressed a queue button, the display will switch to the highest priority condition.

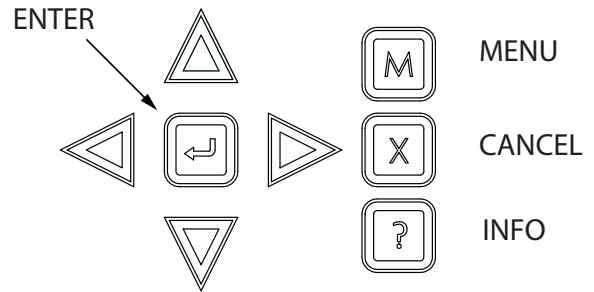

Cursor Buttons

Located around the Enter button, the cursor buttons up (previous), down (next), right, and left allow you to select items on the LCD display. The up and down buttons scroll through lists in a continuous loop.

Enter Button

Use this button to select a displayed item on the LCD display.

Cancel Button

Use this button to cancel an operation or exit a menu.

Menu Button

Use this button to view the Command Menu.

Info Button

Push and hold this button to get detailed information about any displayed item.

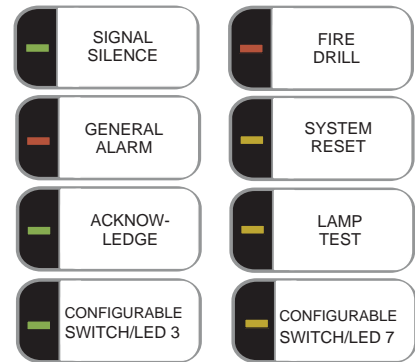

Signal Silence Button

Pressing the Signal Silence button after the panel is in alarm turns ON the Signal Silence LED and deactivates any silenceable indicating circuits. Non-silenceable circuits are unaffected. Signals will re-sound upon any subsequent alarm. This button does not function during any configured Signal Silence Inhibit Timer period. It also does not function if indicating circuits are active as the result of a fire drill. In a Two Stage system, if the Auto General Alarm Timer has not timed out, the Signal Silence button also performs the same function as the Acknowledge button.

Fire Drill Button

The Fire Drill button activates all programmed and non-disconnected indicating circuits, but does not transmit any alarms via the city tie or common alarm relay. The Fire Drill button may be programmed to operate specific indicating circuits. The fire drill is cancelled either by pressing the Fire Drill button again (toggle switch) or if the panel goes into a real alarm.

General Alarm Button

Activation of the General Alarm button immediately sends the panel into general alarm. It will also re-activate the signals if they have been silenced during alarm. The general alarm condition remains active until the panel is reset. Silenceable signals can be silenced using the Signal Silence button.

System Reset Button

The System Reset button resets the panel and all circuits:

- Resets all Latching Trouble Conditions
- Resets all Initiating Circuits
- Resets 4-Wire Smoke Supply
- Turns off all Indicating (NACs) Circuits
- Turns off Signal Silence, Acknowledge and General Alarm LEDs
- Turns off Fire Drill
- Stops and resets all Timers
- Processes inputs as new events
- Aux Disconnect is not affected
- Reset cannot be activated until the Signal Silence Inhibit timer has expired



ATTENTION: The System Reset can be global (all control panels) or by defined Node group (one or more Nodes) as programmed using the MSW-025 MMX™ Configurator Software

Acknowledge Button (Two Stage Only)

If the panel is *not* configured for Two Stage operation, this button could be configured for a different operation. If the panel is configured for Two Stage operation, activation of the Acknowledge button while the Auto General Alarm Timer is timing (e.g. there is an alarm in the panel but it is still in the first stage) cancels the timer and turns the Acknowledge LED on steady amber.

Lamp Test Button

Pressing and holding the Lamp Test button causes all front panel indicators to illuminate and sounds the buzzer steadily. Bi-coloured LEDs will illuminate twice to show both colors. If lamp test is active for more than one minute, the Common Trouble LED activates.

Configurable Switches/LEDs

These two switches and LEDs can be used for any function listed in the MSW-025 MMX™ Configurator Software. Such functions include Buzzer Silence, Auxiliary Disconnect, Total Evacuation, Bypass, System Inputs, and Fan Control.

Troubleshooting

Message	Description
Unconfigured CPU Trouble	This message appears when additional annunciators or loop adders are physically connected to the panel but are not programmed in the Configurator or are configured for the wrong address.
I/O Adder Mismatch Trouble	This message displays when the hardwired adder modules are in the wrong order or the wrong quantity. If the number of physical hardwired adder modules does not match the number of modules listed in the configuration, the panel will display this message. It will also display this message if the adder modules are not connected.
Display Mismatch Trouble	This message displays when the number of display modules (RAX-1048/TZ, FDX-008, and IPS-2424) connected to the panel do not match the number and the order of display modules listed in the configuration. Make sure the display modules are connected.
Unconfigured Device Trouble	This message displays when an analog device is physically installed but does not appear in the configuration program.
Printer Data Loss Trouble	This message displays when a printer is configured but not physically connected to the panel and a message is sent to the printer. Pressing the System Reset button will clear this trouble.
Slave (RAXN-LCDs) Configuration Version Mismatch Trouble	This message displays when the firmware versions on all the CPUs are not compatible.
Slave (RAXN-LCDs) Configuration Address Mismatch Trouble	This message displays when the address(es) of the configured slaves does not match.
Slave Configuration Type Mismatch	This message displays if the physical loop adder does not match the loop adder type specified in the configuration program. For example, you will see this message if the physical adder module is an ALC-396 and the specified adder module in the configuration program is an ALC-H16.
Wrong Device Type	This message displays if the type of analog device does not match the type that is listed in the configuration program. For example, you will see this message if an ionization sensor at address 013 is physically connected to the panel but the configuration program has address 013 listed as a photoelectric sensor (or vice versa).
Multiple Unconfigured Device Trouble	This message displays if there are two identical (duplicate) devices at the same address on the same loop.
Data Link Failure	This message displays if the panel cannot communicate with a remote annunciator or an internal CPU on an adder module.
Data Link Trouble	This message displays when the panel has a communication error with a remote annunciator.
Program Version Mismatch (displayed on the RAXN-LCD only)	This message displays when the RAXN-LCD firmware version is not compatible with the FX-2000N firmware version.
Configuration Data Error (RAM)	This message displays if the system is overloaded and risks resetting itself. Reload the Configurator and/or reboot the system by powering it down and then powering it up.
Configuration Data Error (FLASH)	This message displays if the system is overloaded and risks resetting itself. If this error should occur, please report it to Secutron's Technical Support Department.

Start Up

Before start up, disconnect the network cable.

When the system is plugged in and the batteries are connected, the front display will show:

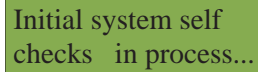



Initial system self
checks in process...

Let the system initialize for approximately one to two minutes.

Download the configuration at each Node using a laptop computer and MMX™ Configurator. Once all the Nodes have been downloaded, connect the network and select the Network Restart (see page 31) at the CACF (Central Alarm and Control Facilities) or main node.

If there is an alarm, supervisory, trouble, or monitor condition in the system, pressing the appropriate queue button and holding  will display information on the cause of the alarm, supervisory, trouble, or monitor device activation.



Note: To display the configuration software version, press  , then hold  .

Passcodes

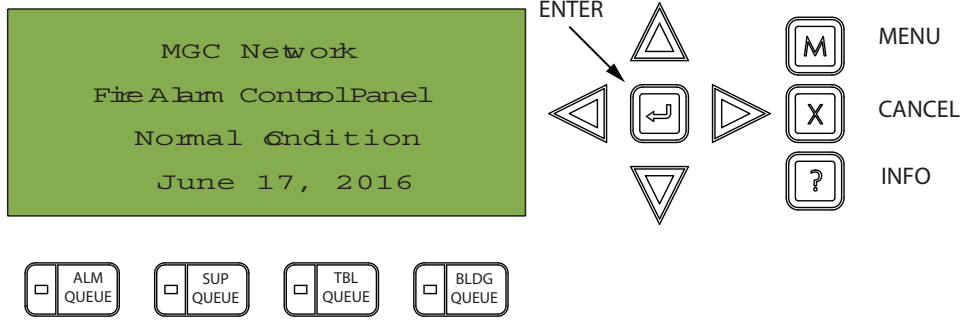

THESE BUTTONS REPRESENT THE CORRESPONDING NUMBER IN THE MENU MODE

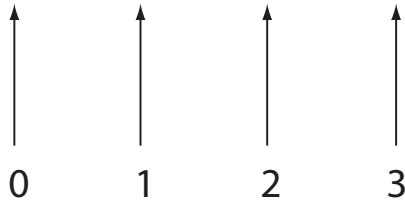

Pressing the Alarm Queue button represents the number 0,
Pressing the Supv. Queue button represents the number 1,
Pressing the Trouble Queue button represents the number 2,
Pressing the BLDG Queue button represents the number 3.

NOTE: THERE IS NO PASSCODE NUMBER AVAILABLE ABOVE 3, THEREFORE, PASSCODES ARE MADE UP OF NUMBERS 0, 1, 2, AND 3 AND CAN BE UP TO 20 DIGITS LONG.

Factory Defaults

FROM THE FACTORY PASSCODES ARE:

Level 1: 1111

Level 2: 2222

Level 3: 3333

A passcode is not required for Level 0 access. Passcodes provide three different levels of menu access. Default passcode 1111 allows Level 1 Access. Default passcode 2222 allows Level 2 access. Default passcode 3333 allows Level 3 access.

ACCESS LEVELS FOR THE FOLLOWING FEATURES, ARE DEFINED (SET AT THE FACTORY) AS:

Reports: 0

Aux. Bypass: 0

Device Bypass: 1

Walk Test: 1

Day/Night Mode: 0

Set Time: 1

Clear Event Log: 2

Clear Verification Count: 2

Config/Network Reset: 2

Manual Enable: 0



Note: You can change these access levels via the MMX™ Configurator MSW-025.

Menu Mode

Press the  button to activate the menu mode. The menu is broken down as follows:

Menu	Submenu	Description	How to Use
1. Reports	Alarm Log	View or print the Alarm Log.	See page 13.
	Event Log	View or print the Event Log.	See page 13.
	Current Levels	View or print the Current Levels.	See page 14.
	Verif. Count	View or print the Verified Count.	See page 15.
	Maint Report	View or print the Maintenance Report.	See page 16.
	Current PWs	View or print Pulse Width Current Report	See page 17.
	Obscuration	View or print the obscuration values	See page 18.
	CO Maint Report	View or print CO detector Maintenance Report	See page 19.
	Battery Voltage	View or print Battery Voltage reading	See page 20.
2. Bypass	Device/Circuit	Bypass/unbypass a Device/Circuit.	See page 22.
	Relay disc	Disconnect/reconnect all relays.	See page 25.
	Input Zone	Disconnect/reconnect input zones per node	See page 25.
3. Walk Test	Audible Test	Perform an audible walktest.	See page 26.
	Silent Test	Perform a silent walktest.	See page 27.
	Assisted (if configured)	Assisted walktest for large systems	See page 29.
4. Day/night mode	N/A	Select day or night mode.	See page 34.
5. Set time	N/A	Set the time and date.	See page 35.
6. Clear Event Log	Alarm Log	Clear the Alarm Log.	See page 36.
	Event Log	Clear the Event Log.	See page 36.
	All Logs	Clear all the logs.	See page 36.
7. Clear Verification Count	N/A	Clear all verification counters.	See page 37.
8. Network Restart	N/A	Select this once system configuration download is completed.	See page 38.
9. Config Info	N/A	Select this feature to view	See page 38.
10. Choose Config	N/A	Select the configuration version you wish to download into the system.	See page 39.



Note: If you have used the Configurator to program the “Enable Required” option in the Command Menu, the Command Menu list will appear differently than that which is shown above. Menu option three will read “Enable Required”, and “Walk Test” will move to menu option four. All subsequent menu options will similarly be renumbered. For more information on the Enable Required option, see page 33.

Front Panel Menu Operation

1. Reports Menu

Use the Reports Menu to print the Alarm Log, Event Log, Current Levels, Verified Counts, Maintenance report, Current PWs, Obscuration, CO Maintenance report, and Battery Voltage. You can view on screen, or print directly to a printer connected to the panel, or to your laptop computer.





Note: To print a report to a printer or to a laptop (using HyperTerminal), the printer output must be enabled via the Configurator.

To enter the Reports Menu, you must be in the Command Menu. To enter the Command Menu, press  when the display is in normal mode.

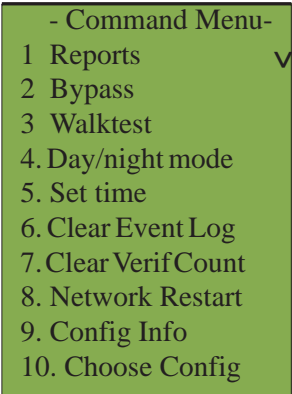
Step 1: Select the Reports Menu



1. Use  and  to scroll the cursor to "Reports".

2. Press  to select the Reports Menu.

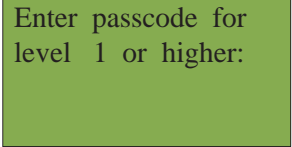

Step 2: Enter your passcode (if required)



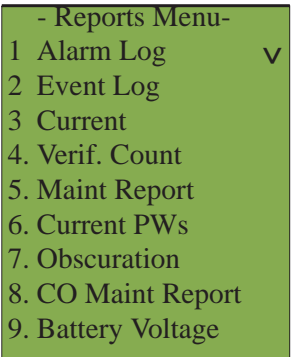

Enter your passcode. See page 10 for instructions on entering passcodes.

Step 3: Select the option you would like to view



1. Use  and  to scroll the cursor through the menu.

2. Press  to select an option.



3. Press  to exit and return to the Reports Menu. Repeat to exit to the Command Menu.

The following subsections provide instructions on using each Reports Menu option.

Alarm Log



The Alarm Log reports on all alarm events. Alarm events are listed in order of the most recent event to the earliest. The maximum number of recorded alarm log entries is 1000. Once the system reaches 1000 entries, any new entry will cause 500 of the oldest entries to be deleted.

Step 1: Select the Alarm Log

- Reports Menu - 1 Alarm Log ▼ 2 Event Log 3 Current Levels	1. Use  and  to scroll to "Alarm Log". 2. Press  to continue.
--	---

At this point the display will vary, depending on whether or not a printer is connected to the panel.



If a printer is not connected to the panel, the Alarm Log will print to the display.

- Use  and  to scroll the cursor through the log.
- Hold  down for more information on the logged event.

Press  to exit to the Reports Menu.

If a printer is connected to the panel, follow Step 2, below.



Step 2: Print the Alarm Log

- Report to - 1 Printer 2 Screen	<ul style="list-style-type: none"> • To print the Alarm Log to the printer, press  when the cursor flashes beside "Printer". • To print the Alarm Log to the screen, press  then  to select "Screen". Follow the instructions above to navigate the Alarm Log.
--	--

Event Log





The Event Log reports on all events: alarms, troubles, and button pushes. Events are listed in order of the latest (most recent) event to the earliest. The maximum number of recorded event log entries is 2000. Once the system reaches 2000 entries, any new entry will cause 1000 of the oldest entries to be deleted.

Step 1: Select the Event Log

- Reports Menu - 1 Alarm Log 2 Event Log ▼ 3 Current Levels	1. Use  and  to scroll the cursor to "Event Log". 2. Press  to continue.
--	--

At this point the display will vary, depending on whether or not a printer is connected to the panel.



If a printer is not connected to the panel, the Event Log will print to the display.

- Use  and  to scroll the cursor through the log.
- Hold  down for more information on the logged event.
- Press  to exit to the Reports Menu.

If a printer is connected to the panel, follow Step 2, below.

Step 2: Print the Event Log

- Report to -
1 Printer
2 Screen



- To print the Alarm Log to the printer, press  when the cursor flashes beside "Printer".
- To view the Alarm Log on the screen, press  then  to select "Screen". Follow the instructions above to navigate the Event Log.

Current Levels

This option reports on the current levels of addressable devices.



Step 1: Select Current Levels

- Reports Menu -
1 Alarm Log
2 Event Log
3 Current Levels v

1. Use  and  to scroll the cursor to "Current Levels".
2. Press  to select the Current Levels submenu.





Step 2: Print or View the Current Levels

- Report to -
1 Printer
2 Screen





- To print the Current Levels report to the printer, press  when the cursor flashes beside "Printer".
- To view the Current Levels report on the screen, press  then  to select "Screen". Follow the instructions above to navigate the Current Levels.

Step 3: Select loop number

-Select Loop Number-
Loop: A L L

- Select a loop number by using  and  to scroll through the numbers, or
- Select all loop numbers by pressing . Wait five seconds. Use  and  to scroll the cursor through the loops.

If you view the Current Levels on the screen,

- Use  and  to scroll the cursor through the log.
- Press and hold  for more information on the current level.
- Press  to exit to the Reports Menu.

For example, if you select loop two, the screen will appear as follows:

```
Loop 2 Address 001
Low Profile ION Det
Current level: 846
Percent alarm: 0%
```



- The first and second lines pinpoint the exact device.
- The **current level** is a point of reference number that is helpful to our technicians.
- The **percent alarm** shows how close the device is to going into alarm: 0% is the least likely, and 80% is the most likely.

Verified Counts

This option reports on any pre-alarmed devices that are set to verification mode. This report lists each time a device pre-alarms. If no devices are set to verification mode, then no report will display.



Step 1: Select Verified Counts

```
- Reports Menu -
2 Event Log      ^
3 Current Levels
4 Verif Count    v
```

1. Use  and  to scroll the cursor to "Verif Counts".
2. Press  to continue.





Step 2: Print or View the Verified Counts

```
- Report to -
1 Printer
2 Screen
```

- To print the Verified Counts to the printer, press  when the cursor flashes beside "Printer".
- To print the Verified Counts to the screen, press  then  when the cursor flashes beside "Screen".

Step 3: Select loop number

```
-Select Loop Number-
Loop: A L L
```

- Select a loop number by using  and  to scroll through the numbers, or
- Select all loop numbers by pressing  and waiting five seconds. Use  and  to scroll the cursor through the loops.

Step 4: If the display shows...





No verified devices found.

...the display will return to the Reports Menu.

OR

If the display shows...

Loop 2 Address
005
Low Profile ION
Det



- Press and hold  to view the details.
- Use  and  to scroll the cursor through the records.
- Press  to exit to the Reports Menu.

Maintenance Report

This option reports on all devices that are greater than 60% of alarm.



Step 1: Select Maintenance Report

- Reports Menu -
3 Current Levels ^
4 Verified Count
5 Maint Report v

1. Use  and  to scroll the cursor to "Maint Report".
2. Press  to continue.



Step 2: Print or View the Maintenance Report

- Report to -
1 Printer
2 Screen

- To print the Maintenance Report to the printer, press  when the cursor flashes beside "Printer".
- To print the Maintenance Report to the screen, press  then  when the cursor flashes beside "Screen".

Step 3: Select loop number

-Select Loop Number-
Loop: _ _ _

- Select a loop number by using  and  to scroll through the numbers, or
- Select all loop numbers by pressing  and waiting five seconds.

Step 4: If the screen shows...





No dirty devices
found.

...the display will return to the Reports Menu.

OR

If the display shows...

Loop 2
Address 001
Low Profile ION
Det



- Press and hold  to view the details.
- Use  and  to scroll the cursor through the records.
- Press  to exit to the Reports Menu.

Current PWs

This option reports on the current levels of addressable devices.



Step 1: Select Current Levels

- Reports Menu -
6 Current PWs ✓
7 Obscuration
8 CO Maint
9 Battery Voltage

1. Use  and  to scroll the cursor to "Current PWs".
2. Press  to select the Current PWs submenu.







Step 2: Print or View Current Levels

- Report to -
1 Printer
2 Screen

- To print the Current Levels report to the printer, press  when the cursor flashes beside "Printer". Go to Step 3.
- To view the Current Levels log on the screen, press  then  to select "Screen". Go to Step 3.

Step 3: Select Node and Loop number

-Select Node & Loop -
Node: A L L

- Select a Node and Loop number by using  and  to scroll through the numbers.
- Select the Node by pressing .
- Select the loop number by pressing . Use  and  to scroll the cursor through the Current Levels, if viewing on the screen.
- Press  to exit to the Reports Menu.

Node 33 Lp2 Addr 1
Photo Detector
1: 0 2: 0 3: 0
4: 0 5: 0



An example of the information displayed on screen:
The first and second line pinpoint the exact device.

Obscuration

This option reports on the obscuration levels of the smoke detectors.



Step 1: Select Obscuration

- Reports Menu -
6 Current PWs
7 Obscuration 
8 CO Maint
9 Battery Voltage

1. Use  and  to scroll the cursor to "Obscuration".
2. Press  to select the Obscuration submenu.







Step 2: Print or View Obscuration

- Report to -
1 Printer
2 Screen

- To print the Obscuration report to the printer, press  when the cursor flashes beside "Printer". Go to Step 3.
- To view the Obscuration log on the screen, press  then  to select "Screen". Go to Step 3.

Step 3: Select Node and Loop number

-Select Node & Loop -
Node: A L L

- Select a Node and Loop number by using  and  to scroll through the numbers.
- Select the Node by pressing  .
- Select the loop number by pressing  . Use  and  to scroll the cursor through the Obscuration, if viewing on the screen.
- Press  to exit to the Reports Menu.

Node 33 Lp2 Addr 1
PhotoDetector
Current Obsc: 0.00%



An example of the information displayed on screen:
The first and second line pinpoint the exact device.
Below that is the present obscuration percentage of the device.

CO Maint

This report specifies which CO device (if used) needs to be replaced.



Step 1: Select CO Maint

- Reports Menu -
6 Current PWs
7 Obscurtion
8 CO Maint 
9 Battery Voltage

1. Use  and  to scroll the cursor to "CO Maint".
2. Press  to select the CO Maint submenu.







Step 2: Print or View CO Maint

- Report to -
1 Printer
2 Screen

- To print the Obscuration report to the printer, press  when the cursor flashes beside "Printer". Go to Step 3.
- To view the CO Maint log on the screen, press  then  to select "Screen". Go to Step 3.

Step 3: Select Node and Loop number

-Select Node & Loop -
Node: A L L

- Select a Node and Loop number by using  and  to scroll through the numbers.
- Select the Node by pressing .
- Select the loop number by pressing . Use  and  to scroll the cursor through the CO Maint, if viewing on the screen.
- Press  to exit to the Reports Menu.

Node 33 Lp2 Addr 1
ReplaceCOdetector



An example of the information displayed on screen:
The first and second line pinpoint the exact CO device which needs to be replaced. The other report will say "No CO Devices to report".

Battery Voltage

This option reports on the voltage level of the battery.



Step 1: Select Battery Voltage

- Reports Menu -
6 Current PWs ^
7 Obscuration
8 CO Maint
9 Battery Voltage v

1. Use  and  to scroll the cursor to "Battery Voltage". Press  to continue.



Step 2: Print or View the Battery Voltage Report

- Report to -
1 Printer
2 Screen

- To print the Battery Voltage Report to the printer, press  when the cursor flashes beside "Printer".
- To view the Battery Voltage on the screen, press  then  when the cursor flashes beside "Screen".

Step 3: Select Node

-Select Node-
Loop: A L L

- Select a Node by using  and  to scroll through the numbers, then  when the correct Node number appears.

Step 4: Pwr Src Report

Battery Voltage
Node 02
Battery: 27.75V

The battery voltage will be displayed as per this example.



2. Bypass Menu

Use the Bypass Menu when you want to bypass or unbypass devices, hardware circuits, complete addressable loops, or outputs such as relays and signals.

To enter the Bypass Menu, you must be in the Command Menu. To enter the Command Menu, press  when the display is in normal mode.

Step 1: Select the Bypass Menu

- Command Menu -
1 Reports
2 Bypass
3 Walktest

1. Use  and  to scroll the cursor to "Bypass".
2. Press  to select the Bypass Menu.





Step 2: Enter your passcode (if required)

Enter passcode for
level 1 or higher:

Enter your passcode. See page 10 for instructions on entering passcodes.

Step 3: Select the option you would like to view

- Bypass Menu -
1 Device /Circuit
2 Relay disc
3 Input Zone

1. Use  and  to scroll the cursor through the Bypass Menu.
 2. Press  to select an option.
- Press  to exit and return to the Bypass Menu.
Repeat to exit to the Command Menu.

The following subsections provide instructions on using each Bypass Menu option.

Device/Circuit Bypass

Use this option if you want to bypass or unbypass a device or circuit from the panel. Usually this is done when you need to add, remove, repair, or investigate a device or circuit.

To unbypass the device or circuit, follow the same procedure for device/circuit bypass.

Step 1: Select Device/Circuit

- Bypass Menu -

1 Device /Circuit

2 Relay Disc

3 Input Zone

Press  when the cursor is flashing beside "Device/Circuit" to select a device.

Step 2: Enter your passcode

Enter passcode for level 1 or higher:

Enter your passcode. See page 10 for instructions on entering passcodes.







Step 3: Select a device

- Select Device -

Node: 0

Loop: 0

Device: 0 0 0

1. Use  and  to select the node, loop and device number.
2. Enter the node number, then press .
3. Enter the loop number, then press .
4. Enter the device number, pressing  and  as needed to move left and right.
5. Press  to continue.



Step 4: Bypass the device/circuit

Strobe Output

Floor 2

L0 000 not

bypassed. Bypass? Y

1. The systems now asks you whether or not you would like to bypass or unbypass the device. Use  and  to select "yes" or "no".
2. Press  to continue.

At this point the display will vary, depending on your choice:

- **If you selected "yes"**, the system will display the message "Device/Circuit bypassed (unbypassed)", then it will return to the Bypass Menu.
- **If you selected "no"**, the system will display the message "Operation cancelled", then it will return to the Bypass Menu.

Unbypassing an active device/circuit

When you unbypass a device or circuit that went into alarm while it was bypassed, you will see the following message:



Warning: This output device is active.
Do you really want to unbypass it? Y

If you select “yes” to unbypass this device, the system will immediately go into alarm. To avoid this problem, press the System Reset button before unbypassing a device or circuit.



Relay Disconnect

This option is useful if you want to disconnect or reconnect the aux relays.

Step 1: Select Relay Disconnect

<p>- Bypass Menu - 1 Device /Circuit 2 Relay Disc 3 Input Zone</p>	<p>1. Use  and  to scroll the cursor to “Relay Disc”.</p> <p>2. Press  to continue.</p>
--	--

Step 2: Select “yes” or “no”

<p>Common aux relays currently connected Disconnect? <u>Y</u></p>	<p>1. The systems now asks you whether or not you would like to bypass the aux relays. Use  and  to select “yes” or “no”.</p> <p>2. Press  to continue.</p>
---	--

At this point the display will vary, depending on your choice:

- **If you selected “yes”**, the display will either show the message “Relays disconnected” or “Relays reconnected”, then it will return to the Command Menu.
- **If you selected “no”**, the display will show the message “Operation cancelled”, then it will return to the Command Menu.

Input Zone Bypass





WARNING: Bypassing an input zone will disable all input devices in that loop.

Use this option if you want to bypass an entire zone of addressable devices from the panel. Usually this is done during building maintenance.



To unbypass the input zone, follow the same procedures for input zone bypass.

Step 1: Select Input Zone Bypass

<p>- Bypass Menu - 1 Device /Circuit 2 Relay Disc 3 Input Zone</p>	<p>1. Use  and  to scroll the to “Input Zone”.</p> <p>2. Press  to continue.</p>
--	---

Step 2: Select a loop number



-Select Input Zone-
Node: 1
CPU: 1

1. Use  and  to select the Node and CPU number.

2. Press  to continue.

Step 3: Bypass the loop

Nd: __ CPU: __ Zn: __
Bypass? Y

1. The systems now asks you whether or not you would like to bypass or unbypass the input zone.
Use  and  to select "yes" or "no".

2. Press  to continue.

At this point the display will vary, depending on your choice:

- **If you selected "yes"**, the display will either show the message "Input Zone bypassed" or "Input Zone unbypassed", then return to the Command Menu.
- **If you selected "no"**, the display will show the message "Operation cancelled" and will then return to the Command Menu.

Unbypassing an active loop

When you unbypass a input zone that went into alarm while it was bypassed, you will see the following message:

Warning: This zone is active. Do you really want to unbypass it? Y

If you select "yes" to unbypass this loop, the system will immediately go into alarm. To avoid this problem, press the System Reset button before unbypassing the loop.

3. Walk Test Menu

Use the Walk Test Menu when you want to test the devices in a system. Performing a walk test will place the system in trouble (non-latching).





Note: Walk test records that are viewed on the screen will be stored in the event log.

To enter the Walk Test Menu, you must be in the Command Menu. To enter the Command Menu, press  when the display is in normal mode.

Step 1: Select the Walk Test Menu

```
- Command Menu -
1 Reports
2 Bypass
3 Walktest
```

1. Use  and  to scroll the cursor to "Walktest".
2. Press  to select the Walk Test Menu.





Step 2: Enter your passcode (if required)

```
Enter passcode for
level 1 or higher:
```

Enter your passcode. See page 10 for instructions on entering passcodes.





Step 3: Select the option you would like to view

```
- Walktest -
1 One Man
2 Walktest report
```

1. Use  and  to scroll the cursor through the menu.
 2. Press  to select an option.
- Press  to exit and return to the Command Menu.

Step 4: Select the One Man to see this next menu

```
- Walktest -
1 Audible Test
2 Silent Test
```

1. Use  and  to scroll the cursor through the menu.
 2. Press  to select an option.
- Press  to exit and return to the Command Menu.

The subsections following provide instructions on using each One Man Walk Test Menu option, Audible Test and Silent Test.

Audible Test

During this test, alarm activation of any input device will activate all signals for one half second. Trouble activation on any input device will activate all signals continuously for one second. If audio amplifier is configured for alarm and trouble events, it will sound words “Alarm” and “Trouble” respectively.



Note: Audible devices connected to an addressable output module will not sound in Audible Test mode.

Step 1: Select Audible Test

- Walktest -

1 Audible Test

2 Silent Test

1. Use and to scroll the cursor to “Audible Test”.
2. Press when the cursor flashes beside “Audible Test” to select the Audible Test.

Step 2: Select duration of Walk Test

- Walktest -

Timeout 6 hours

1. The default duration of Walk Test is 6 hours. To choose another time duration, use the and to scroll the cursor to the desired duration time. Valid range is from 1 hour to 12 hours.

Press to select the Walk Test duration.

Step 3: Start the Walk Test

- Walktest -

1 Start

2 Resume

Start or Resume Test for device inspection.

1. Select Start to begin a Walk Test.
2. Select Resume to continue the Walk Test.

As the test runs, the Alarms and Troubles count will increase as they are recorded (logged) during the Audible Test.

Press to end the walk test at any time.

Step 4: Main Walk Test Screen

OneMan

A:xxxx D:xxxx R:xxxx

T:xxxx D:xxxx R:xxxx

Press CANCEL to end

During the Walk Test the display will be as shown.

A = number of Walk Test alarm events

T = number of Walk Test trouble events

D = number of duplicate alarm and trouble events

R = number of remaining alarm and trouble events from the Walk Test list

Use and to scroll the cursor through the devices in the Walk Test list. Pressing the up/down keys will switch the view to display the Walk Test list. This view allows selection of the device to be tested.

Step 5: Device View During the Walk Test

```
Nnn Lnn Adrrrrrrrrrr
A: nnn T:nnn
Tag 1
Tag 2
```

During the Walk Test the device display will be as shown.

A = total number of alarm events for the device.

T = total number of trouble events for the device.

Press  or  to switch to the Main Walk Test screen.



Press  to exit the Walk Test at anytime.

Silent Test

During this test, alarm and trouble activation of any input device will be recorded by the system but it will not sound the signals. For the system to register a trouble, you must keep the device in a trouble condition for 10 seconds.

Step 1: Select Silent Test



```
- Walktest -
1 Audible Test
2 Silent Test
```

1. Use  and  to scroll the cursor to "Silent Test".

2. Press . The test will now begin.

Step 2: Select duration of Walk Test

```
- Walktest -
Timeout 6 hours
```

1. The default duration of Walk Test is 6 hours. To choose another time duration, use the  and  to scroll the cursor to the desired duration time. Valid range is from 1 hour to 12 hours.

Press  to select the Walk Test duration.

Step 3: Start the Walk Test

```
- Walktest -
1 Start
2 Resume
```

Start or Resume Test for device inspection.

1. Select Start to begin a Walk Test.

2. Select Resume to continue the Walk Test.

As the test runs, the Alarms and Troubles count will increase as they are recorded (logged) during the Audible Test.



Press  to end the walk test at any time.

Step 4: Main Walk Test Screen

<pre>OneMan A:xxxx D:xxxx R:xxxx T:xxxx D:xxxx R:xxxx Press CANCEL to end</pre>	<p>During the Walk Test the display will be as shown.</p> <p>A = number of Walk Test alarm events T = number of Walk Test trouble events D = number of duplicate alarm and trouble events R = number of remaining alarm and trouble events from the Walk Test list</p>
---	--

Step 5: Device View During the Walk Test

<pre>Nnn Lnn Adrnnnnnnnnn A: nnn T:nnn Tag 1 Tag 2</pre>	<p>During the Walk Test the device display will be as shown.</p> <p>A = total number of alarm events for the device. T = total number of trouble events for the device.</p>
--	---

Press  or  to switch to the Main Walk Test screen.

Press  to exit the Walk Test at anytime.



Assisted Walk Test

Assisted Walk Test must be configured using the Configurator. When the Assisted Walk Test is configured, the One Man Walk Test is replaced by the Assisted Walk Test. The Assisted Walk Test shall be in silent mode only.

To enter the Walk Test Menu, you must be in the Command Menu. To enter the Command Menu, press  when the display is in normal mode.

Step 1: Select the Walk Test Menu

- Command Menu -
 1 Reports
 2 Bypass
 3 Walktest

1. Use  and  to scroll the cursor to "Walktest".
2. Press  to select the Walk Test Menu.



Step 2: Enter your passcode (if required)

Enter passcode for level 1 or higher:

Enter your passcode. See page 10 for instructions on entering passcodes.

Step 3: Select the Assisted Walk Test option



- Walktest -
 1 Assisted
 2 Walktest report

1. Use  and  to scroll the cursor through the menu.
2. Press  to select the "Assisted" option.

Press  to exit and return to the Command Menu.

Step 4: Select the Assisted Walk Test to see this next menu

- Walktest -
 1st Floor
 2nd Floor



1. Use  and  to scroll the cursor through the menu.
2. Press  to select an area for testing.
3. Start inspecting devices. All alarm and trouble events shall be saved in the Walk Test log.

Press  to exit and return to the Command Menu.

Step 5: Main Walk Test Screen

During the Assisted Walk Test the display will be as shown.

1st Floor
A:xxxx D:xxxx R:xxxx
T:xxxx D:xxxx R:xxxx
Press CANCEL to end

1. Use  and  to scroll the cursor through the devices.

A = number of Walk Test alarm events
T = number of Walk Test trouble events
D = number of duplicate events other than alarm and troubles
R = number of remaining events from the Walk Test list

Press  to exit and return to the Command Menu.

Step 5: Walk Test Device Screen

Nnn Lnn Adrrnnnnnnnn
A: nnn T:nnn
Tag 1
Tag 2

Device display will be as shown.

A = total number of alarm events for the device.
T = total number of trouble events for the device.



Walk Test Report

The Walk Test Report provides on screen and printer logs for both the One Man Walk Test and the Assisted Walk Test. To enter the Walk Test Menu, you must be in the Command Menu. To enter the Command Menu, press  when the display is in normal mode.

Walk Test Screen Report

Step 1: Select the Walk Test Menu

- Command Menu -
1 Reports
2 Bypass
3 Walktest

1. Use  and  to scroll the cursor to "Walktest".

2. Press  to select the Walk Test Menu.



Step 2: Enter your passcode (if required)

Enter passcode for level 1 or higher:

Enter your passcode. *See page 10 for instructions on entering passcodes.*

Step 3: Select the Walk Test Report



- Walktest -
1 One Man
2 Walktest report

1. Use  and  to scroll the cursor through the menu.

2. Press  to select "Walktest report" option.

Step 4: Select the Screen option

```
- Walktest -
1 Printer
2 Screen
```



1. Use  and  to scroll the cursor through the menu.

2. Press  to select an "Screen" option.

Press  to exit and return to the Command Menu.

Step 5: Walk Test Report on Screen

```
One Man(or 1st Floor)
A:nnnn D:nnnn R:nnnn
T: nnnn D:nnnn R:nnnn
Press CANCEL to end
```

Use  and  to scroll the cursor through the Walk Test log.

Press  to exit and return to the Command Menu.

Step 5: Walk Test Device Report on Screen

```
Nnn Lnn Adrnnnnnnnnn
A: nnn T:nnn
Tag 1
Tag 2
```



Device display will be as shown.

A = total number of alarm events for the device.

T = total number of trouble events for the device.

Walk Test Printer Report**Step 1: Select the Walk Test Menu**

```
- Command Menu -
1 Reports
2 Bypass
3 Walktest
```

1. Use  and  to scroll the cursor to "Walktest".

2. Press  to select the Walk Test Menu.



Step 2: Enter your passcode (if required)

```
Enter passcode for
level 1 or higher:
```

Enter your passcode. *See page 10 for instructions on entering passcodes.*

Step 3: Select the Walk Test Report

```
- Walktest -
1 One Man
2 Walktest report
```

1. Use  and  to scroll the cursor through the menu.

2. Press  to select the "Walktest report" option.



Press  to exit and return to the Command Menu.

Step 4: Select the Printer option

- Walktest -

1 Printer

2 Screen

1. Use  and  to scroll the cursor through the menu to Printer.

2. Press  to select Printer.

Press  to exit and return to the Command Menu.

The following is an example of a printed Walk Test Report:

```

----- - Walktest - - Jun 11,2015 15:22:07 -----
----- Job Name: walktest -----
----- Job version: 1.0 -----
----- Firmware version: 12.0.1 (Node 17, CPU 0) -----
Walktest test
A: 4 D: 1 R: 6
T: 1 D: 1 R: 9
=====
Adr: 1 A: 0 T: 0
Nd:17 CPU: 1 L: 3
coptir on addr 1 on qla
=====
Adr: 101 A: 0 T: 0
Nd:17 CPU: 0 L: 2
Input 101 first node
=====
Adr: 103 A: 0 T: 0
Nd:17 CPU: 0 L: 2
Input 103 first node
=====
Adr: 101 A: 0 T: 0
Nd:17 CPU: 1 L: 3
virtual coptir 101 on qla
=====
Adr: 104 A: 1 T: 0
Nd:17 CPU: 0 L: 2
Input 104 first node
=====
Adr: 106 A: 1 T: 0
Nd:17 CPU: 0 L: 2
input 106 first node
=====
Adr: 107 A: 2 T: 0
Nd:17 CPU: 0 L: 2
input 107 first node
=====
Adr: 94 A: 1 T: 2
Nd:17 CPU: 1 L: 3
ion on addr 94 on qla
=====
Adr: 111 A: 0 T: 0
Nd:17 CPU: 1 L: 4
=====
Adr: 12 A: 0 T: 0
Nd:17 CPU: 1 L: 4
=====
----- End of Report -----
    
```

Alternate Menu Option #3: Manual Control Enable



Notes:

- You will see this option in the Command Menu only if your system has been programmed for manual control.
- This feature does not change after a system reset.

This option provides security on the panel control buttons by requiring the user to enter a passcode or activate a key switch before a specific button will operate. This “manual control” feature is set up using the Configurator, and can affect any number of control buttons. Selecting the Enable Required option in the Command Menu or turning the key switch allows you to activate and deactivate this feature.

Selecting Manual Control Enable from the Menu

To select the Enable Required option, you must be in the Command Menu. To enter the Command Menu, press



when the display is in normal mode.

Step 1: Select Manual Enable

- Command Menu-
1 Reports
2 Bypass
3 Man Ctrl Enable

1. Use and to scroll the cursor to “Man Ctrl Enable”.
2. Press to continue.

Step 2: Enter your passcode

Enter passcode for level 1 or higher:

Enter your passcode. See page 10 for instructions on entering passcodes.

Step 3: Enable manual control

Manual control currently disabled.
Enable? Y

1. The systems now asks you whether or not you would like to enable manual control. Use and to select “yes” or “no”.
2. Press to continue.

The display will now show the message “Manual control enabled” while in normal mode, and the panel will be in a trouble condition. To check which annunciator manual control was enabled on, press the button. To disable manual control, follow the same steps outlined above.

Selecting manual control enable using a key switch

You can set up the MMX™ to require the activation of a key switch instead of a passcode to enable manual control. Once the key switch is operated, the display will show the message “Manual control enabled” while in normal mode, and the panel will be in a trouble condition. To check which annunciator manual control was enabled on, press the button. To disable manual control, reset the key switch.

4. Day/Night Mode

Using the Configurator you can program day mode and night mode separately for different system sensitivity levels. Select the Day/Night mode option in the Command Menu if you would like to manually set the Day/Night mode.

To enter the Day/Night Mode option, you must be in the Command Menu. To enter the Command Menu, press



when the display is in normal mode.

Step 1: Select Day/Night Mode

- Command Menu - 3 Walktest 4 Day/night mode 5 Set time	1. Use and to scroll the cursor to “Day/Night mode” 2. Press to continue.
--	---

Step 2: Enter your passcode (if required)

Enter passcode for level 2 or higher:	Enter your passcode. <i>See page 10 for instructions on entering passcodes.</i>
---------------------------------------	---

Step 3: Select “yes” or “no”

Day/night mode set to auto daytime operation Change? <u>Y</u>	1. Use and to select “yes” or “no”. 2. Press to continue.
--	---

At this point the display will vary, depending on your choice:

- **If you selected “yes”**, continue to step 3.
- **If you selected “no”**, the display will show the message “Operation cancelled”, and then it will return to the Command Menu.

Step 4: Select Mode

- Select Mode - 1 Manual Daytime 2 Manual Night 3 Auto day/night	1. Use and to select “Manual Daytime”, “Manual Night”, or “Auto day/night”. 2. Press to continue. The display will now return to the Command Menu.
---	--



Note: The panel will stay in the mode you select until you change it to another mode.

5. Set Time







Note: Select this option if you would like to set the time only. You must use the Configurator to change the date.

To enter the Set Time option, you must be in the Command Menu. To enter the Command Menu, press  when the display is in normal mode.

Step 1: Select Set Time

- Command Menu -
4 Day/Night mode
5 Set Time
6 Clear Event Log

1. Press  to select the Command Menu.
2. Use  and  to scroll the cursor to “Set Time”.
3. Press  when the cursor flashes beside “Set Time” to select the Set Time option.





Step 2: Enter your passcode (if required)

Enter passcode for level 2 or higher:

Enter your passcode. See page 10 for instructions on entering passcodes.

Step 3: Set the Time

- Change Time -
Time: 12:08 PM









- Use  and  to change the time.
- Use  and  to move from hours, to minutes, to AM/PM.
- When you are finished, press  to return to the Command Menu.
- The system will display the message “Time updated” and return to the Command Menu.

6. Clear Event Log

Select this option if you would like to clear the Alarm Log, Event Log, or all the logs.

To enter the Clear Event Log option, you must be in the Command Menu. To enter the Command Menu, press

M when the display is in normal mode.

Step 1: Select Clear Event Log	
- Command Menu- 4 Day/Night mode 5 Set Time 6 Clear Event Log	1. Use  and  to scroll the cursor to "Clear Event Log". 2. Press  to continue.
Step 2: Enter your passcode (if required)	
Enter passcode for level 2 or higher:	Enter your passcode. <i>See page 10 for instructions on entering passcodes.</i>
Step 3: Select the log to clear	
- Select Log - 1 Alarm Log 2 Event Log 3 All Logs	<ul style="list-style-type: none"> •Use  and  to select the log you would like to clear. •Use  and  to select "yes" or "no". •Press  to continue. •The system will display the messages "Please stand-by erasing log..." and "Log(s) cleared"" and will return to the Command Menu.
Are you sure you want to clear all the entries in the selected log(s)? <u>Y</u>	



7. Clear Verification Counter

Select this option if you would like to clear the verification counter.

To enter the Clear Verification Counter Option, you must be in the Command Menu. To enter the Command Menu, press  when the display is in normal mode.

Step 1: Select Clear Verification Counter

- Command Menu-
5 Set Time/Date
6 Clear Event Log
7 Clr Verif Count

1. Use  and  to scroll the cursor to “Clear Verification Counter”.

2. Press  to continue.

Step 2: Enter your passcode (if required)

Enter passcode for level 2 or higher:

Enter your passcode. *See page 10 for instructions on entering passcodes.*

Step 3: Select “yes” or “no”

Clear all verification counters? Y

1. Use  and  to select “yes” or “no”.

2. Press  to continue.

At this point the display will vary, depending on your choice:

- **If you selected “yes”**, the display shows the message “Counters cleared “, then it will return to the Command Menu.
- **If you selected “no”**, the display shows the message “Operation cancelled”, then it will return to the Command Menu.



8. Network Restart

Use the Network Restart after downloading the MMX™ configuration.

To select the Network Restart, you must be in the Command Menu. To enter the Command Menu,

press  when the display is in normal mode.



Step 1: Select Network Restart

- Command Menu - 6 Clear Event Log 7 Clr Verif Count 8 Network Restart	1. Use  and  to scroll the cursor to “Network Restart”. 2. Press  to continue.
---	--

Step 2: Enter your passcode (if required)

Enter passcode for level 2 or higher:	Enter the passcode. <i>See page 10 for instructions on entering passcodes.</i> Default is Level 2 passcode required.
---------------------------------------	---

Step 3: Select “yes” or “no” to auto program

Are you sure you want to reboot whole network (all nodes and CPUs)? <u>Y</u>	1. Use  and  to select “yes” or “no”. 2. Press  to continue.
--	--

At this point the display will vary, depending on your choice:

- **If you selected “no”**, the display shows the message “Operation cancelled”, then it will return to the Command Menu.
- **If you selected “yes”**, the system begins a reset and the display shows:

Initial system self
 checks in process ...
 Version 10.1.5

9. Configuration Info

Select this option if you would like to see the information regarding the configuration in the system.

The MMX™ display will show the following while in Configuration Info mode:



- Config Info -
 Key ID: 0xffffffff
 ESD No: 0xffffffff
 Tech No: 0xffffffff

10. Choose Configuration

Select this option if you would like to select the configuration version to upload into the system.

Step 1: Select Choose Configuration

```
- Command Menu -
8 Network Restart
9 Config Info
10 Choose Config
```

1. Use  and  to scroll the cursor to "Choose Config".
2. Press  to continue.

Step 2: Enter your passcode (if required)



```
Enter passcode for
level 2 or higher:
```

Enter your passcode. *See page 10 for instructions on entering passcodes.*

The MMX™ display will show the following while in Choose Config mode:



Step 3: Select the Configuration version to Upload

```
- Config Info -
V1: Job Name
V2: Job Name Rev 1
V3: Job Name Rev 2
```

- Use  and  to select the which version of configuration (up to 3 versions) you wish to upload.
- Press  to download the version.

Step 5: Select "yes" or "no"

```
Are you sure you
want to change the
system
configuration? Y
```

- Use  and  to select "yes" or "no".
- Press  to continue.

At this point the display will vary, depending on your choice:

- If you select "no", the display shows the message "Operation Cancelled", then it will return to the Command Menu.
- If you select "yes", the system begins the upload of the configuration and the display shows:

```
System
Configuration
in process ...
```

Paging Operation

QMP-5101N and QMP-5101NV Network Master Paging Indicators and Controls

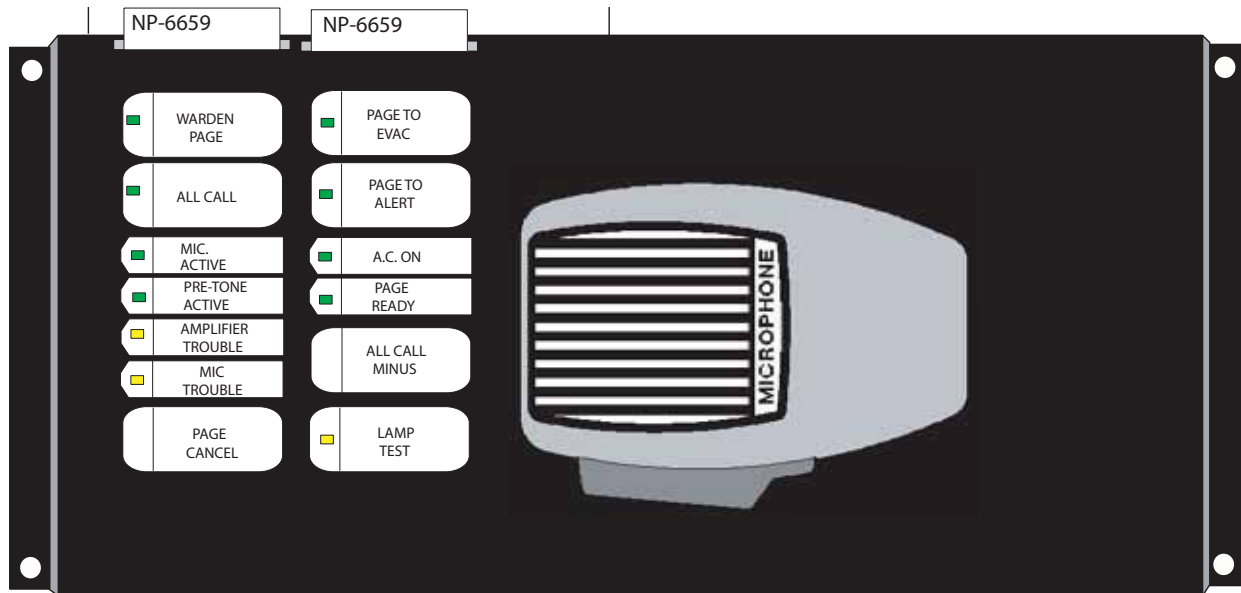

This section describes the controls and indicators on the QMP-5101N (shown in figure above) and QMP-5101NV Master Paging and QAZT-5302 Paging Selector Modules. The QMP-5101NV is similar to the QMP-5101N except mounting is vertical.

QMP-5101N/V LEDs

Amplifier Trouble LED

Indicates any QX-5000N amplifier internal trouble.

Warden Page

Illuminates steady green to indicate that the Warden Page function is active.

All Call

Illuminates steady green to indicate that the All-Call function is active. This LED will not function if the DIP switch SW1-5 is set to ON.

Mic Active LED

Flashes green to indicate any activity on the paging bus (i.e. other microphone in use). Illuminates steady green when associated microphone (at proximity of LED) is in use.

Pre-Tone Active LED

Steady green when paging and warden paging

Amplifier Trouble LED

Indicates any QX-5000N amplifier internal trouble.

Mic Trouble LED

Flashes amber to indicate a microphone trouble.

Page to Evac LED

Illuminates steady green when the Page to Evac pushbutton is active.

Page to Alert LED

Illuminates steady green when the Page to Alert pushbutton is active.

AC ON LED

This green LED illuminates steadily to indicate that AC power is present.

Page Ready LED

Illuminates steady green when the push-to-talk (PTT) on the microphone is depressed (active).

Lamp Test LED

This amber LED illuminates steadily to indicate that the Lamp Test has been activated.

OMP-5101N/V Pushbutton Controls**Warden Page Button**

When depressed, the Warden Page button enables voice paging from the firefighters' telephone (if connected) to all zones selected for paging, unless page inhibit is active. Note that pressing PTT will not result in any paging activity unless there are zones selected for paging. Also note that there must be an active firefighters' telephone connection for warden paging to occur.

All-Call Button

Selects all zones for voice paging. This button will not function if DIP switch SW1-5 Automatic All-Call is set to ON.

All-Call Minus Button

Inverts the selection of zones for voice paging. This button will not function if DIP switch SW1-5 Automatic All-Call is set to ON.

Page to Evac

Pressing this button selects all the audio zones currently in evacuation mode, for paging.

Page to Alert

Pressing this button selects all the audio zones currently in alert mode, for paging.

Page Cancel

Pressing this button de-selects all zones (including those manually selected) from paging.

Lamp Test Button

Momentarily activates all LED indicators.

Microphone PTT Button

The microphone's PTT (push-to-talk) button is located on the microphone itself. When depressed, allows voice paging (from the microphone) to be enabled to all zones selected for paging, unless page cancel is active. Note that pressing PTT will not result in any paging activity unless there are zones selected for paging.

QAZT-5302 Paging Selector Panel

Each QAZT-5302 annunciates and controls up to 24 paging zones. There is one button and two LEDs per zone. The lower amber LED indicates zone trouble. The upper green LED indicates whether that zone is selected for paging communication.

Paging zone selection buttons toggle ON and OFF voice paging for that zone.

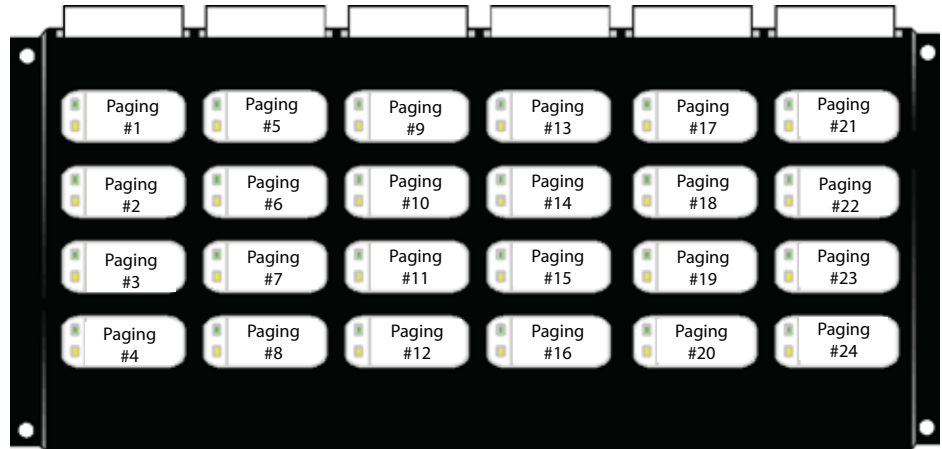

Note: Use configurator to set up the QAZT-5302 Paging Zone Selector Panels.

QAZT-5302 Paging Selector Panel LEDs

Page LED

Illuminates green if the zone is selected for voice paging.

Trouble LED

Flashes amber to indicate that the zone is in trouble.

QAZT-5302 Pushbuttons

Page Button (if enabled)

Selects / deselects that zone for voice paging.

Telephone Operation

QMT-5302N/QMT-5302NV Master Firefighters' Telephone Indicators and Controls

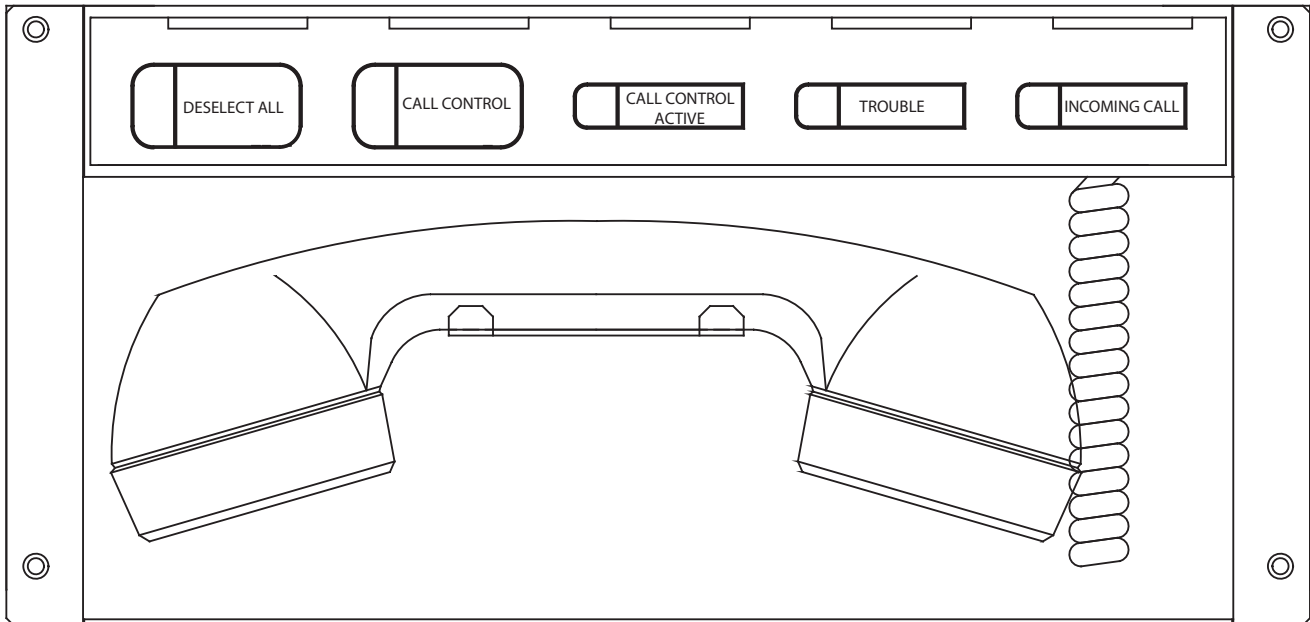

This section describes the controls and indicators on the QMT-53021N (in figure above) and QMT-53021NV Master Telephone and QAZT-5302 Telephone Selector Modules. The QMT-53021NV is similar to the QMT-53021N except the mounting is vertical.

QAZT-5302 Network Firefighters' Telephone Selector Panel

Each QAZT-5302 annunciates and controls up to 24 telephone zones. There is one button and two LEDs per zone. The lower amber LED indicates zone trouble. The upper green LED indicates whether that zone is selected for telephone communication.

Telephone zone selection buttons toggle ON and OFF telephone communication for that zone.

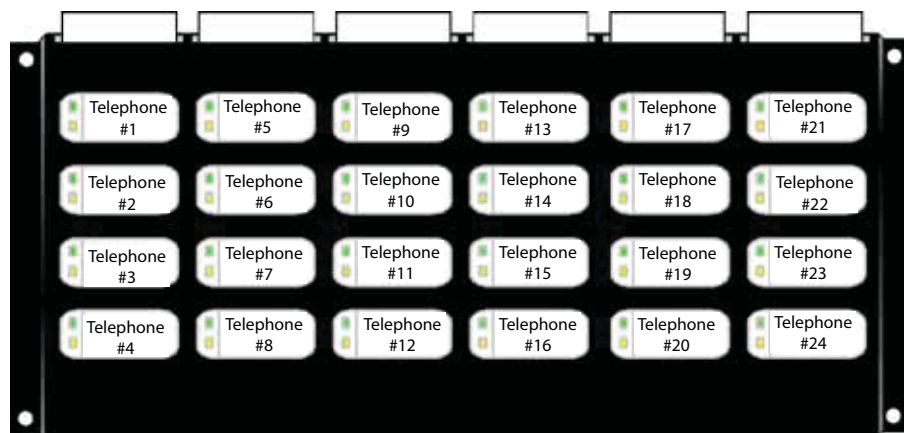

Note: Use configurator to set up the QAZT-5302 Telephone Zone Selector Panels.

Telephone Operation

1. When any telephone zone rings (the local buzzer sounds intermittently, and the green zone LED and Incoming Call LED flash) press that zone's button (on the selector panel QAZT-5302) once to answer. Once any one zone has been answered, calls from any other zone will cause that zone's green LED and the Incoming Call LED at the master telephone to flash and the buzzer will sound.
2. Press the answered zone's button once again to hang up. (Note that the telephone zone will hang up automatically if all handsets on the zone are placed back on the hook)

QMT-5302N Master Telephone LEDs

Trouble LED

This LED will flash amber if there is any trouble at the master telephone.

Incoming Call LED

This LED will flash green if any telephone zone has a handset off-hook and unanswered. It will illuminate steady green if all telephone zones with off-hook handsets have been answered.

Call Control Active LED

This LED will illuminate when there is a connection between the designated Master Telephone (at the CACF) and the present QMT-5302N telephone.

QMT-5302N Master Telephone Pushbutton Controls

Call Control

Pressing this pushbutton will connect this master telephone with all master telephones as configured.

Deselect All

Pressing this pushbutton will disconnect all master telephones calls initiated from this node (Call Control minus).

QAZT-5302 Network Firefighters' Telephone Selector Panel LEDs

Telephone Zone Green LED

This LED will flash green if there is any handset off-hook on that zone, and the zone has not been answered by pressing the zone's button. Once answered, the LED will be steady green.

Telephone Zone Amber LED

This LED will flash amber to indicate trouble on open-circuit zone faults (e.g. missing end-of-line resistor or wire breaks) or short-circuit zone faults.

QAZT-5302 Network Firefighters' Telephone Selector Panel Pushbutton Controls

Telephone Selection Pushbutton

Pressing the telephone selector pushbutton will select the associated telephone to be connected to the Master Telephone. Pressing this button a second time will hang up.



© 2017 Secutron Inc.

No part of this publication may be reproduced, transmitted, transcribed, stored in a retrieval system, or translated into any language or computer language, in any form by any means electronic, magnetic, optical, chemical, manual, or otherwise without the prior consent of Secutron.

Canada
25 Interchange Way
Vaughan, ON L4K 5W3
Tel: (888) SECUTRON
(905) 695-3545
Fax: (905) 660-4113

U.S.A
4575 Witmer Industrial Estates
Niagara Falls, New York 14305
Tel: (888) SECUTRON
(905) 695-3545
Fax: (905) 660-4113

Technical Support
North America Only
Tel: (888) SECUTRON
(905) 695-3545
International
Tel: (905) 695-3545